

SMART OFFICE SOLUTIONS

UNIQUX HEAD DESK

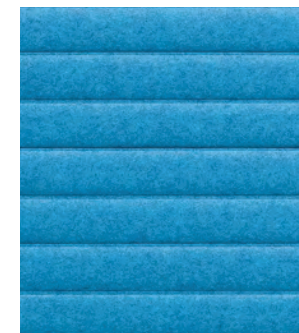

PLANMAX

Head / Factory 8-21, Neungheodaero 625beon-gil, Namdong-gu, Incheon, Republic of Korea (21700)
 Overseas Sales Division #819-2 LI-Center 50, Hogupo-ro, Namdong-gu, Incheon, Republic of Korea (21688)
 For local sales T. 82-70-8245-7660 F. 82-32-721-4670 E. sales@eplanmax.com
 For overseas sales T. 82-70-8245-7650 E. info@eplanmax.com

www.eplanmax.com

2019.08.30

PLANMAX

FURNITURE WHICH
MAKES PEOPLE
COMFORTABLE AND
HAPPY



Pleasant Workspace Play Office

An office has to be one of the most important places since people spend a major part of their time here. As people are central to the success of any business, we offer office furniture which makes people comfortable and happy. We make future-oriented offices where infinite imaginative power and creative thinking work together. This is the "PLAY OFFICE" - the office concept that PLANMAX is presenting.



C | O | N | T | E | N | T | S

PANEL SYSTEM

- 06 _ UNIQU_ MX,MO
- 12 _ UNIQU_ MF,MA,MC,MS
- 18 _ T-PLANMAX_ 30T
- 22 _ PANEL_ 45T
- 26 _ e-PLANMAX_ 60T
- 32 _ PLANMAX_ 70T

WORKSTATION SERIES

- 40 _ HEAD DESK
- 44 _ VIBRANT
- 48 _ SUM UP
- 52 _ EXO
- 56 _ CUBE
- 60 _ FU_STAND

PANEL SYSTEM

UNIQU

T-PLANMAX 30T

PANEL 45T

e-PLANMAX 60T

PLANMAX 70T

UNIQUX

Space renewing innovation items



Sound absorption PARTITION

Partitions that absorb 30% of the noise-
It's quieter to divide and replace space.



The lightest PARTITION in the world

Light to lift. Light to change the layouts.
Lightly divide and change the space.



Eco-friendly PARTITION

Eco-friendly certification partition,
which is difficult to get due to strict
standards. Divide and change space
with more healthily.

MX

Divide, add, remove the color...

To prevent all spaces in the partition world that design space in color according to the style and sense of space, from becoming normal. Create partitions that add innovation to innovation
Space is more convenient, quieter, new.





UNIQUX

Space renewing innovation items



Sound absorption PARTITION

Partitions that absorb 30% of the noise-
It's quieter to divide and replace space.



The lightest PARTITION in the world

Light to lift. Light to change the layouts.
Lightly divide and change the space.



Eco-friendly PARTITION

Eco-friendly certification partition,
which is difficult to get due to strict
standards. Divide and change space
with more healthily.

MO

Fold and unfold, orange, black, yellow...

Design your space in your own color, depending on the style and sense of every space.

It's more convenient, more quietly, to re-create the space with different ideas beyond the familiar and the ordinary.





Details



MX

GENERAL TYPE

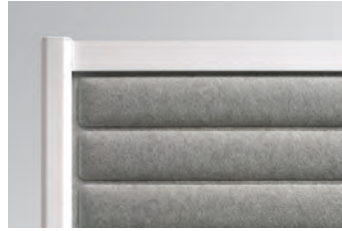

TILE PATTERN(MX, MO)

Felt material has a good design and excellent acoustic function.



Split Face on Partition Tiles(MX)

The tiles can be plane-partitioned in the form of a rectangle and a square.



BASE(MX)

The bottom support maintains a stable support and balance.



"L"TYPE CONNECTION(MX)

"L" connection using post as well as stand alone.



MO

FOLDABLE TYPE



WINDOW PATTERN(MX, MO)

The polycarbonate double-structured window is safe and translucent.



VARIOUS COLOR(MX, MO)

It provides free space separation and is easy to store.

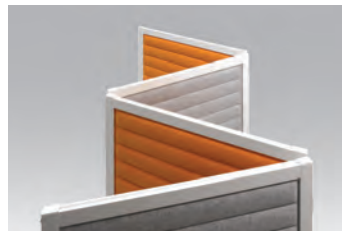

FOLDABLE PARTITION(MO)

It provides free space separation and is easy to store.



Adding functionality in tiles

Felt-based tiles have the added function of anti-foul, waterproof, and lint-resistant.

Finishings / Felt Color



C201



C202



C203



C204



C205



C206



C207



C208





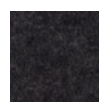















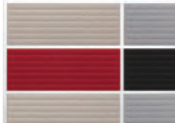







C209







C210

MX (GENERAL TYPE)

						
MX 1212 20 MX 1212L 20 W1200×T40×H1200	MX 1212 12 MX 1212L 12 W1200×T40×H1200	MX 1812 22 MX 1812L 22 W1780×T40×H1200	MX 1812 14 MX 1812L 14 W1780×T40×H1200	MX 2412 40 MX 2412L 40 W2360×T40×H1200	MX 2412 32 MX 2412L 32 W2360×T40×H1200	MXP 12 H1195 (Post L Type)
						
MX 1214 30 MX 1214L 30 W1200×T40×H1420	MX 1214 22 MX 1214L 22 W1200×T40×H1420	MX 1814 33 MX 1814L 33 W1780×T40×H1420	MX 1814 25 MX 1814L 25 W1780×T40×H1420	MX 2414 60 MX 2414L 60 W2360×T40×H1420	MX 2414 52 MX 2414L 52 W2360×T40×H1420	MXP 14 H1416 (Post L Type)
						
MX 1216 30 MX 1216L 30 W1200×T40×H1600	MX 1216 22 MX 1216L 22 W1200×T40×H1600	MX 1816 33 MX 1816L 33 W1780×T40×H1600	MX 1816 25 MX 1816L 25 W1780×T40×H1600	MX 2416 60 MX 2416L 60 W2360×T40×H1600	MX 2416 52 MX 2416L 52 W2360×T40×H1600	MXP 16 H1596 (Post L Type)
						
MX 1218 30 MX 1218L 30 W1200×T40×H1780	MX 1218 22 MX 1218L 22 W1200×T40×H1780	MX 1818 33 MX 1818L 33 W1780×T40×H1780	MX 1818 25 MX 1818L 25 W1780×T40×H1780	MX 2418 60 MX 2418L 60 W2360×T40×H1780	MX 2418 52 MX 2418L 52 W2360×T40×H1780	MXP 18 H1776 (Post L Type)

MO (FOLDABLE TYPE)

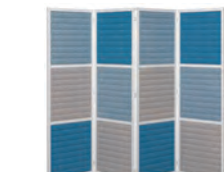
					
MO 0212 W1240×T16×H1200	MO 0312 W1860×T16×H1200	MO 0412 W2480×T16×H1200	MO 0218 W1240×T16×H1780	MO 0318 W1860×T16×H1780	MO 0418 W2480×T16×H1780

UNIQUX

Space renewing innovation items



Sound absorption PARTITION

Partitions that absorb 30% of the noise-
It's quieter to divide and replace space.



The lightest PARTITION in the world

Light to lift. Light to change the layouts.
Lightly divide and change the space.



Eco-friendly PARTITION

Eco-friendly certification partition,
which is difficult to get due to strict
standards. Divide and change space
with more healthily.

MF / MA / MC / MS

Beyond the conventional, thought-provoking, ordinary,
mind-boggling ideas,
new partitions design innovative spaces that go beyond
the limits of space.





Details



MF

GENERAL TYPE_FOR DESK

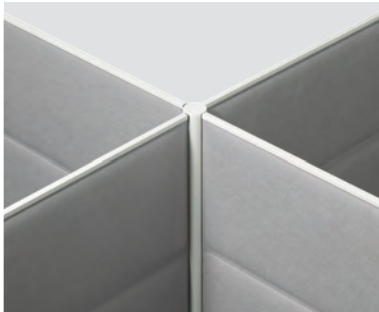

POST

Make it possible to be I, L, T & X way configuration.



TILE

Felt tiles are excellent in design and sound absorption.



BASE COVER

Help to accommodate wires convenient and neatly.(Optional)



WIRE DUCT (Post attached type)

Attach a wire duct and socket box to the post.



WIRE DUCT (Desk attached type)

Attach a wire duct and socket box to the under the table top.



DESK CONNECTOR

Possible to be fixed with the desk.



CONNECTING & EXTENSION

UNIQU provides efficient space due to the free of connecting and extension.



ACC(Memo board & Shelf)

Magnetic memo board and shelves for the practical use.



POST BASE (Stabilizer)

Keep stable support and balance as a base prop.

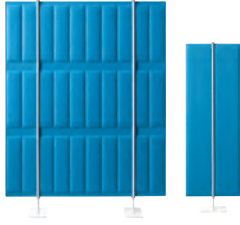

MA
INDIVIDUAL TYPE



MC
INDIVIDUAL TYPE_ROUND



MS
SCREEN

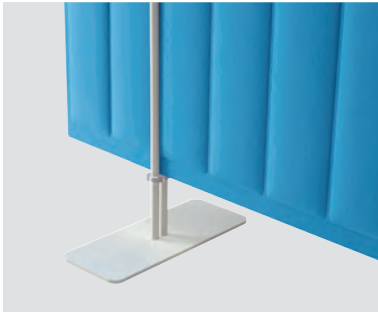

SUPPORT (Plate)
The support (plate) connect to two bars and forms a stable structure.



FLEXIBLE TILE
Adjust the desired angles and curves, and provide the optimum space for the user.



TILE
Felt tiles are excellent in design and sound absorption.



TILE
Vertical pattern felt tile.



POST
Keeps the curved tiles on a stable.



FIXED (Desk mounted) Desk
Mounted screen produces the same image as the partition.

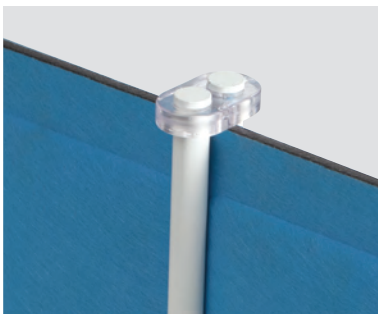

STOPPER
Plastic injection stopper keeps the gap between bars and a tile.



ACRYLIC TILE
Ideal for open feeling and for changing configuration of the partitions.



MOVABLE
Flexible movement and use as a side screen as well.

MF / MA / MC / MS (GENERAL TYPE)

UXIQX has an individual type and multiple combination connecting type, and each type is completed by combining the necessary components according to specifications

GENERAL TYPE



MF 0612 W600 X T20 X H1160
MF 0712 W700 X T20 X H1160
MF 0812 W800 X T20 X H1160
MF 1012 W1000 X T20 X H1160
MF 1212 W1200 X T20 X H1160
 ※Dimensions including a post

GENERAL TYPE _TOP ACRYLIC



MF 0612G W600 X T20 X H1160
MF 0712G W700 X T20 X H1160
MF 0812G W800 X T20 X H1160
MF 1012G W1000 X T20 X H1160
MF 1212G W1200 X T20 X H1160
 ※Dimensions including a post

GENERAL TYPE



MF 0614 W600 X T20 X H1370
MF 0714 W700 X T20 X H1370
MF 0814 W800 X T20 X H1370
MF 1014 W1000 X T20 X H1370
MF 1214 W1200 X T20 X H1370
 ※Dimensions including a post

GENERAL TYPE _TOP ACRYLIC



MF 0614G W600 X T20 X H1370
MF 0714G W700 X T20 X H1370
MF 0814G W800 X T20 X H1370
MF 1014G W1000 X T20 X H1370
MF 1214G W1200 X T20 X H1370
 ※Dimensions including a post

INDIVIDUAL TYPE_ ROUND



MC 1013
 W1000 X T10 X H1290
 ※Dimensions including MPC 13

INDIVIDUAL TYPE_ ROUND TOP ACRYLIC



MC 1013G
 W1000 X T10 X H1290
 ※Dimensions including MPC 13

INDIVIDUAL TYPE_ ROUND



MC 1017
 W1000 X T10 X H1690
 ※Dimensions including MPC 17

INDIVIDUAL TYPE_ ROUND TOP ACRYLIC



MC 1017G
 W1000 X T10 X H1690
 ※Dimensions including MPC 17

POST



MPC 13
 H1290(ø250)
MPC 17
 H1690(ø250)

SPECIAL ITEMS

BASE COVER



MBC 06 W600
MBC 07 W700
MBC 08 W800
MBC 10 W1000
MBC 12 W1200

WIRE DUCT_ Post attached type



MD 500
 (Not including socket box)

WIRE DUCT_ Desk attached type



MD 501
 (Not including socket box)

DESK CONNECTOR



MH 001

MEMO BOARD



MH 002
 W600 X H218

SHELF



MH 003
 W450 X D168 X H45







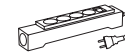

MH 004
 W303 X D212 X H32







SOCKET BOX

















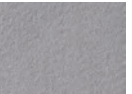

KM 502
 (4 power + plug in code 1.5m)

Applicable components for MF model: MPI, MPL, MPT, MPX, MPZ

GENERAL TYPE		GENERAL TYPE_TOP ACRYLIC		POST					
				I_TYPE	L_TYPE	T_TYPE	X_TYPE	STABLE TYPE	
									
MF 0616 W600 X T20 X H1580	MF 0716 W700 X T20 X H1580	MF 0816 W800 X T20 X H1580	MF 1016 W1000 X T20 X H1580	MF 1216 W1200 X T20 X H1580	MF 0616G W600 X T20 X H1580	MF 0716G W700 X T20 X H1580	MF 0816G W800 X T20 X H1580	MF 1016G W1000 X T20 X H1580	MF 1216G W1200 X T20 X H1580
※Dimensions including a post		※Dimensions including a post		MPI 12 H1160	MPL 12 H1160	MPT 12 H1160	MPX 12 H1160	MPZ 12 H1160(ø250)	
				MPI 14 H1370	MPL 14 H1370	MPT 14 H1370	MPX 14 H1370	MPZ 14 H1370(ø250)	
				MPI 16 H1580	MPL 16 H1580	MPT 16 H1580	MPX 16 H1580	MPZ 16 H1580(ø250)	

INDIVIDUAL TYPE				SCREEN	
					
MA 1013 W980 X T20 X H1300	MA 1016 W980 X T20 X H1560	MA 0411 W420 X T20 X H1080	MA 0413 W420 X T20 X H1280	MSM 1004 W1000 X T20 X H400	MSF 1004 W1000 X T20 X H400
				MOVABLE	FIXED_Desk mounted
					

Finishings / Felt Color

									
M116	M311	M136	M128	M146	M319	M308			
									
C201	C202	C203	C204	C205	C206	C207	C208	C209	C210

T-PLANMAX

Partition innovation

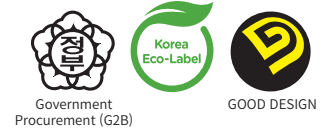

30T

T-PLANMAX with ultra-thin thickness of 30T is the modular system office panel matching well with any office space or desk of any structure and available in various sizes up to the double width.



Ultra-slim, lightweight, and functional module system for departmental and team.



30T (T-PLANMAX)

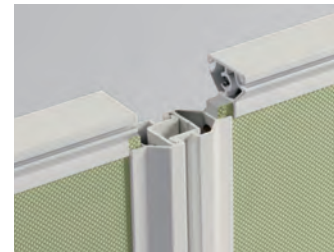

FRAME CONNECTING TO BE INSTALLED SO QUICKLY AND EASILY

The finish bar has the structure same as that of frame connection. It has the simple structure that can shorten the time for panel assembly and reduce the use of parts.



ASSEMBLE WITHOUT THE TOOL CONNECTOR

T-PLANMAX is a panel system with easy assembly and disassembly, connectable to the frame using only the connector without need for separate tools.



DESK COUPLING CONNECTOR DESIGNED BY THE IDEA AND TECHNOLOGY UNIQUE TO PLANMAX

It is a connection system ensuring very convenient and robust connection of panel and desk and applicable to the desk of any size.

Running Item

POST - L TYPE

GP-12L H1148
GP-14L H1348
GP-16L H1548

POST - T TYPE

GP-12T H1148
GP-14T H1348
GP-16T H1548

POST - X TYPE

GP-12X H1148
GP-14X H1348
GP-16X H1548

SIDE FINISHED COVER

GE-12 H1148
GE-14 H1348
GE-16 H1548

SIDE FINISHED COVER

GH-002

H 1160mm

GENERAL TYPE - STEEL TOP



- G00-0612S** W600×T30×H1160
- G00-0712S** W700×T30×H1160
- G00-0812S** W800×T30×H1160
- G00-1012S** W1000×T30×H1160
- G00-1212S** W1200×T30×H1160
- G00-1412S** W1400×T30×H1160
- G00-1612S** W1600×T30×H1160
- G00-1812S** W1800×T30×H1160

GENERAL TYPE - WOODEN TOP



- G00-0612** W600×T30×H1160
- G00-0712** W700×T30×H1160
- G00-0812** W800×T30×H1160
- G00-1012** W1000×T30×H1160
- G00-1212** W1200×T30×H1160
- G00-1412** W1400×T30×H1160
- G00-1612** W1600×T30×H1160
- G00-1812** W1800×T30×H1160

GENERAL TYPE - STEEL TOP



- G0T-0612S** W600×T30×H1160
- G0T-0712S** W700×T30×H1160
- G0T-0812S** W800×T30×H1160
- G0T-1012S** W1000×T30×H1160
- G0T-1212S** W1200×T30×H1160
- G0T-1412S** W1400×T30×H1160
- G0T-1612S** W1600×T30×H1160
- G0T-1812S** W1800×T30×H1160

GENERAL TYPE - WOODEN TOP



- G0T-0612** W600×T30×H1160
- G0T-0712** W700×T30×H1160
- G0T-0812** W800×T30×H1160
- G0T-1012** W1000×T30×H1160
- G0T-1212** W1200×T30×H1160
- G0T-1412** W1400×T30×H1160
- G0T-1612** W1600×T30×H1160
- G0T-1812** W1800×T30×H1160

GLASS TOP TYPE



- G0T-0612G** W600×T30×H1160
- G0T-0712G** W700×T30×H1160
- G0T-0812G** W800×T30×H1160
- G0T-1012G** W1000×T30×H1160
- G0T-1212G** W1200×T30×H1160
- G0T-1412G** W1400×T30×H1160
- G0T-1612G** W1600×T30×H1160
- G0T-1812G** W1800×T30×H1160

H 1360mm

GENERAL TYPE - STEEL TOP



- G0T-0614S** W600×T30×H1360
- G0T-0714S** W700×T30×H1360
- G0T-0814S** W800×T30×H1360
- G0T-1014S** W1000×T30×H1360
- G0T-1214S** W1200×T30×H1360
- G0T-1414S** W1400×T30×H1360
- G0T-1614S** W1600×T30×H1360

GENERAL TYPE - WOODEN TOP



- G0T-0614** W600×T30×H1360
- G0T-0714** W700×T30×H1360
- G0T-0814** W800×T30×H1360
- G0T-1014** W1000×T30×H1360
- G0T-1214** W1200×T30×H1360
- G0T-1414** W1400×T30×H1360
- G0T-1614** W1600×T30×H1360

GLASS TOP TYPE



- G0T-0614G** W600×T30×H1360
- G0T-0714G** W700×T30×H1360
- G0T-0814G** W800×T30×H1360
- G0T-1014G** W1000×T30×H1360
- G0T-1214G** W1200×T30×H1360
- G0T-1414G** W1400×T30×H1360
- G0T-1614G** W1600×T30×H1360

H 1560mm

GENERAL TYPE - STEEL TOP



- G0T-0616S** W600×T30×H1560
- G0T-0716S** W700×T30×H1560
- G0T-0816S** W800×T30×H1560
- G0T-1016S** W1000×T30×H1560
- G0T-1216S** W1200×T30×H1560

GENERAL TYPE - WOODEN TOP



- G0T-0616** W600×T30×H1560
- G0T-0716** W700×T30×H1560
- G0T-0816** W800×T30×H1560
- G0T-1016** W1000×T30×H1560
- G0T-1216** W1200×T30×H1560

GLASS TOP TYPE



- G0T-0616G** W600×T30×H1560
- G0T-0716G** W700×T30×H1560
- G0T-0816G** W800×T30×H1560
- G0T-1016G** W1000×T30×H1560
- G0T-1216G** W1200×T30×H1560

PANEL

Office life creative

45T

PANEL 45T features slim, aesthetic design that fits in any office space with all the functions of a workstation that maximizes office space utilization. It also provides a comfortable atmosphere and a simple office space





Slim design 45mm Thickness make your office more efficiency. Steel frame and metal bar provide concrete structure.

45T



Open self



Aluminum bar

End bar
Aluminum end bar with Hook for easy and simple assembly.



Panel cover
Aluminum panel cover and post.



Easy leveling



Wooden and metal tile

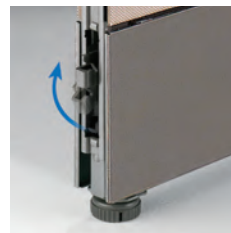

Connector
Stable connecting structure.



Height adjustable leveler



One post system

Using one post for L, X, T shape partition assembly. Minimize assembly time and lower the cost for installation. For different height partition connection, do not need to consider about its height. One height can cover both height.

Union Operation Model

H 1070mm

METAL TOP



BASIC TYPE

FP45-760	W600 X T45 X H1070
FP45-770	W700 X T45 X H1070
FP45-780	W800 X T45 X H1070
FP45-7100	W1000 X T45 X H1070
FP45-7120	W1200 X T45 X H1070



GLASS TOP TILE TYPE

FPG45-760	W600 X T45 X H1070
FPG45-770	W700 X T45 X H1070
FPG45-780	W800 X T45 X H1070
FPG45-7100	W1000 X T45 X H1070
FPG45-7120	W1200 X T45 X H1070

H 1170mm

METAL TOP



BASIC TYPE

FP45-1160	W600 X T45 X H1170
FP45-1170	W700 X T45 X H1170
FP45-1180	W800 X T45 X H1170
FP45-11100	W1000 X T45 X H1170
FP45-11200	W1200 X T45 X H1170



GLASS TOP TILE TYPE

FPG45-1160	W600 X T45 X H1170
FPG45-1170	W700 X T45 X H1170
FPG45-1180	W800 X T45 X H1170
FPG45-11100	W1000 X T45 X H1170
FPG45-11200	W1200 X T45 X H1170

H 1370mm

METAL TOP



BASIC TYPE

FP45-1360	W600 X T45 X H1370
FP45-1370	W700 X T45 X H1370
FP45-1380	W800 X T45 X H1370
FP45-13100	W1000 X T45 X H1370
FP45-13120	W1200 X T45 X H1370



GLASS TOP TILE TYPE

FPG45-1360	W600 X T45 X H1370
FPG45-1370	W700 X T45 X H1370
FPG45-1380	W800 X T45 X H1370
FPG45-13100	W1000 X T45 X H1370
FPG45-13120	W1200 X T45 X H1370

H 1570mm

METAL TOP



BASIC TYPE

FP45-1560	W600 X T45 X H1570
FP45-1570	W700 X T45 X H1570
FP45-1580	W800 X T45 X H1570
FP45-15100	W1000 X T45 X H1570
FP45-15120	W1200 X T45 X H1570



GLASS TOP TILE TYPE

FPG45-1560	W600 X T45 X H1570
FPG45-1570	W700 X T45 X H1570
FPG45-1580	W800 X T45 X H1570
FPG45-15100	W1000 X T45 X H1570
FPG45-15120	W1200 X T45 X H1570

H 1770mm

METAL TOP



BASIC TYPE

FP45-1760	W600 X T45 X H1770
FP45-1770	W700 X T45 X H1770
FP45-1780	W800 X T45 X H1770
FP45-17100	W1000 X T45 X H1770
FP45-17120	W1200 X T45 X H1770



GLASS TOP TILE TYPE

FPG45-1160	W600 X T45 X H1770
FPG45-1170	W700 X T45 X H1770
FPG45-1180	W800 X T45 X H1770
FPG45-11100	W1000 X T45 X H1770
FPG45-11200	W1200 X T45 X H1770

POST



- FPP45-7** W45 X T45 X H1070
- FPP45-11** W45 X T45 X H1170
- FPP45-13** W45 X T45 X H1370
- FPP45-15** W45 X T45 X H1570
- FPP45-17** W45 X T45 X H1770

END BAR



- FPE45-7** W45 X T15 X H1070
- FPE45-11** W45 X T15 X H1170
- FPE45-13** W45 X T15 X H1370
- FPE45-15** W45 X T15 X H1570
- FPE45-17** W45 X T15 X H1770

STABILIZER



- FP45-375** W375 X T65 X H130

Finishings / PANEL 45T Fabric color

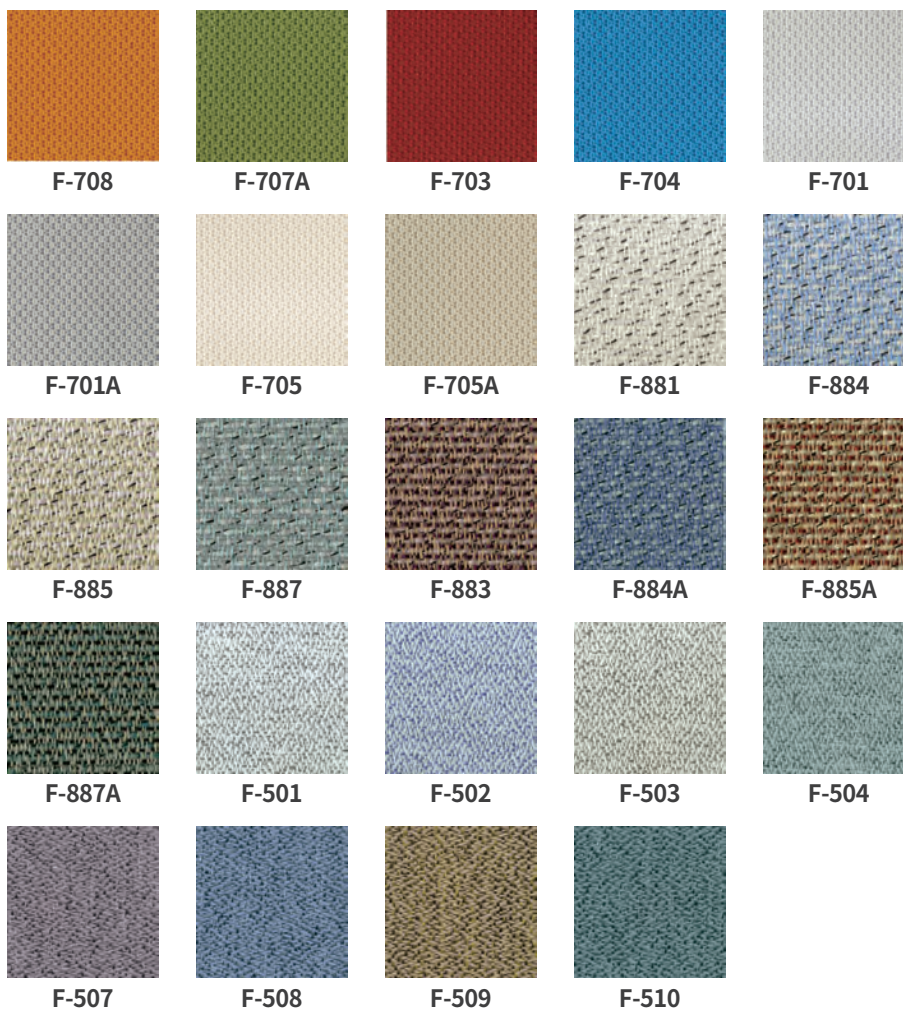

e-PLANMAX

Partition innovation



601

e-PLANMAX has the look and feel of permanence, but can easily be modified to adjust to the changing work environment. Whether adding panels to increase privacy, adding overhead cabinets for storage space or removing panels to foster a more open, collaborative environment, e-PLANMAX has the flexibility to accomplish it all.



The combination of slim design and clean colors provides a simple, comfortable environment for office space.



HANGING SHELF



SHELF SUPPORT SHELF

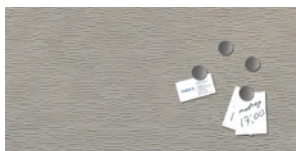

FABRIC TILE

As the tile is made of iron plate and covered with fabric, it can be used as a memo board using a magnet.



SOUND ABSORBING TILE

As the sound-absorbing tile is built-in within the iron plate structure and is covered with fabric, sound absorption ability is very excellent.



GLASS TILE

The tile can be applied to the space in which user's privacy is secured and openness is required as well.



SCREEN GLASS TILE

As it is made of silk screen, the tile can be used more suitably than glass-tile when privacy is more required.

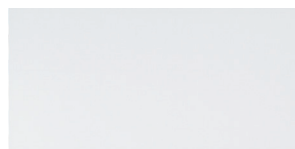

MARKER BOARD TILE

The tile can be used as a marker-board.



ACCESSORY GRILL TILE

Any other accessories can be angled on the rail-style groove.



WOOD-PATTERN SHEET TILE

The tile is covered with wood-pattern sheet whose surface intensity is excellent and thus it is suitable for noble space.

60T (e-PLANMAX)



BELT TILE HINGE
Developed by e-PLANMAX's own technique, spring hinge applied to belt tile opens and closes smoothly and makes allocating easy when fully opened.



FINISH RUBBER
Rubber is attached to the bottom of belt tile, making the line drawn out easily.

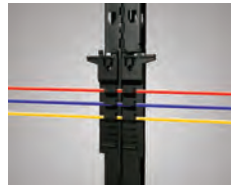

WIRING OF BELT LINE
Wire clip is attached in the middle of frame, so users can arrange the wires without twist of lines.



BELT TILE
The main reason that e-PLANMAX is distinguished from other products is allocating system. It is designed by open-style allocating way, not frame-penetrating method. This method helps users control the allocation and the e-PLANMAX embeds a large amount of wires. Thus, this provides a perfect working environment for each users in the office.



STABILIZER
Slim stabilizer, minimizing hooking foot.

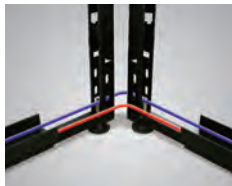

WIRING OF BASE LINE
Wire housing enables large amount of allocation.

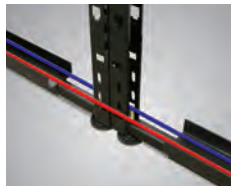

FRAME CONNECTOR
Using connector, e-PLANMAX's unique combination is made. The connector made of high impact plastic mould enables system-construction without any tools fast.



e-PLANMAX not only boasts slim design, enlivening color and economic feasibility, but also adopts an open wiring system that encompasses high-capacity wiring and makes it easy to care.

Side Panel

Composed of polycarbonate, the side panel blocks the unwanted viewers from outside and adds an elegant look to your office. You can also adjust the angle to place it wherever you want.



TILE



MARKER BOARD TILE

KT-0804B W789×T15×H398
KT-1004B W989×T15×H398



ACCESSORY GRILL TILE

KT-0602TR W590×T12×H198
KT-0702TR W690×T12×H198
KT-0802TR W790×T12×H198
KT-1002TR W990×T12×H198
KT-1202TR W1190×T12×H198
KT-0604TR W590×T14×H398
KT-0704TR W690×T14×H398
KT-0804TR W790×T14×H398
KT-1004TR W990×T14×H398
KT-1204TR W1190×T14×H398

OVERHEAD CABINET



KS-0602 W600×D343×H410
KS-0702 W700×D343×H410
KS-0802 W800×D343×H410
KS-1002 W1000×D343×H410
KS-1202 W1200×D343×H410

POST

L_TYPE



KSP-12L W60×T28×H1144
KSP-14L W60×T28×H1344

T/X_TYPE



KSP-12T/X W60×T28×H1144
KSP-14T/X W60×T28×H1344

L_TYPE

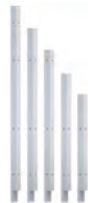

KP-10L W60×T60×H944
KP-12L W60×T60×H1144
KP-14L W60×T60×H1344
KP-16L W60×T60×H1544
KP-18L W60×T60×H1744

T_TYPE



KP-10T W60×T60×H944
KP-12T W60×T60×H1144
KP-14T W60×T60×H1344
KP-16T W60×T60×H1544
KP-18T W60×T60×H1744

X_TYPE



KP-10X W60×T60×H834
KP-12X W60×T60×H1034
KP-14X W60×T60×H1234
KP-16X W60×T60×H1434
KP-18X W60×T60×H1634

FINISHED COVER

SIDE



KE-10 W60×T8×H944
KE-12 W60×T8×H1144
KE-14 W60×T8×H1344
KE-16 W60×T8×H1544
KE-18 W60×T8×H1744

GAP



KE-02D W60×T8×H200
KE-04D W60×T8×H400
KE-06D W60×T8×H600
KE-08D W60×T8×H800

SIDE PANEL



KSA-0812 W800×T28×H1160
KSA-0814 W800×T28×H1360
KSA-1012 W1000×T28×H1160
KSA-1014 W1000×T28×H1360

WORKTOP SUPPORT SHELF



KA-406 W600×D168
KA-407 W700×D168
KA-408 W800×D168
KA-410 W1000×D168
KA-412 W1200×D168

SHELF



KS-0601 W600×D300×H154
KS-0701 W700×D300×H154
KS-0801 W800×D300×H154
KS-1001 W1000×D300×H154
KS-1201 W1200×D300×H154

PAPER SHELF



KA-301 W304×D223×H67

PAPER SHELF



KA-302 W113×D223×H314

CD SHELF



KA-303 W132×D140×H154

PEN VASE



KA-304 W85×D92×H122

STABILIZER



KA-100 W440×D125×H114

WALL BRACKET



KA-200 W35×D30×H70

Union Operation Model

H 960mm

H 1160mm

H 1360mm

GENERAL TYPE



KTT-0610 W600×T60×H960
KTT-0710 W700×T60×H960
KTT-0810 W800×T60×H960
KTT-1010 W1000×T60×H960
KTT-1210 W1200×T60×H960

GENERAL TYPE



KTT-0612 W600×T60×H1160
KTT-0712 W700×T60×H1160
KTT-0812 W800×T60×H1160
KTT-1012 W1000×T60×H1160
KTT-1212 W1200×T60×H1160

GENERAL TYPE



KTT-0614 W600×T60×H1360
KTT-0714 W700×T60×H1360
KTT-0814 W800×T60×H1360
KTT-1014 W1000×T60×H1360
KTT-1214 W1200×T60×H1360

SINGLE BELT TYPE



KTB-0610 W600×T60×H960
KTB-0710 W700×T60×H960
KTB-0810 W800×T60×H960
KTB-1010 W1000×T60×H960
KTB-1210 W1200×T60×H960

SINGLE BELT TYPE



KTB-0612 W600×T60×H1160
KTB-0712 W700×T60×H1160
KTB-0812 W800×T60×H1160
KTB-1012 W1000×T60×H1160
KTB-1212 W1200×T60×H1160

SINGLE BELT TYPE



KTB-0614 W600×T60×H1360
KTB-0714 W700×T60×H1360
KTB-0814 W800×T60×H1360
KTB-1014 W1000×T60×H1360
KTB-1214 W1200×T60×H1360

DOUBLE BELT TYPE



KBB-0610 W600×T60×H960
KBB-0710 W700×T60×H960
KBB-0810 W800×T60×H960
KBB-1010 W1000×T60×H960
KBB-1210 W1200×T60×H960

DOUBLE BELT TYPE



KBB-0612 W600×T60×H1160
KBB-0712 W700×T60×H1160
KBB-0812 W800×T60×H1160
KBB-1012 W1000×T60×H1160
KBB-1212 W1200×T60×H1160

DOUBLE BELT TYPE



KBB-0614 W600×T60×H1360
KBB-0714 W700×T60×H1360
KBB-0814 W800×T60×H1360
KBB-1014 W1000×T60×H1360
KBB-1214 W1200×T60×H1360

SINGLE WIRING BELT TYPE



KTE-0710 W700×T60×H960
KTE-0810 W800×T60×H960
KTE-1010 W1000×T60×H960
KTE-1210 W1200×T60×H960

SINGLE WIRING BELT TYPE



KTE-0712 W700×T60×H1160
KTE-0812 W800×T60×H1160
KTE-1012 W1000×T60×H1160
KTE-1212 W1200×T60×H1160

SINGLE WIRING BELT TYPE



KTE-0714 W700×T60×H1360
KTE-0814 W800×T60×H1360
KTE-1014 W1000×T60×H1360
KTE-1214 W1200×T60×H1360

BELT / WIRING BELT TYPE



KBE-0710 W700×T60×H960
KBE-0810 W800×T60×H960
KBE-1010 W1000×T60×H960
KBE-1210 W1200×T60×H960

BELT / WIRING BELT TYPE



KBE-0712 W700×T60×H1160
KBE-0812 W800×T60×H1160
KBE-1012 W1000×T60×H1160
KBE-1212 W1200×T60×H1160

BELT / WIRING BELT TYPE



KBE-0714 W700×T60×H1360
KBE-0814 W800×T60×H1360
KBE-1014 W1000×T60×H1360
KBE-1214 W1200×T60×H1360

DOUBLE WIRING BELT TYPE



KEE-1210 W1200×T60×H960

DOUBLE WIRING BELT TYPE



KEE-1212 W1200×T60×H1160

DOUBLE WIRING BELT TYPE



KEE-1214 W1200×T60×H1360

* WIRING BELT TYPE : ONLY APPLICATION THE W 700, 800, 1000, 1200
 * BOTH SIDES WIRING BELT TYPE : ONLY APPLICATION THE W 1200

H 1560mm

H 1760mm

GLASS TOP H1160~H1760

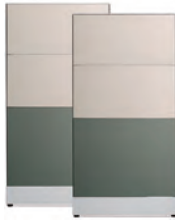

GENERAL TYPE

KTT-0616 W600×T60×H1560
KTT-0716 W700×T60×H1560
KTT-0816 W800×T60×H1560
KTT-1016 W1000×T60×H1560
KTT-1216 W1200×T60×H1560

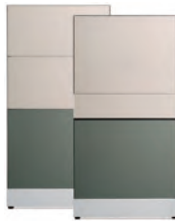

SINGLE BELT TYPE

KTB-0616 W600×T60×H1560
KTB-0716 W700×T60×H1560
KTB-0816 W800×T60×H1560
KTB-1016 W1000×T60×H1560
KTB-1216 W1200×T60×H1560

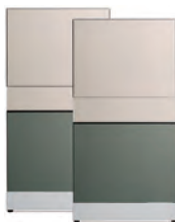

DOUBLE BELT TYPE

KBB-0616 W600×T60×H1560
KBB-0716 W700×T60×H1560
KBB-0816 W800×T60×H1560
KBB-1016 W1000×T60×H1560
KBB-1216 W1200×T60×H1560



SINGLE WIRING BELT TYPE

KTE-0716 W700×T60×H1560
KTE-0816 W800×T60×H1560
KTE-1016 W1000×T60×H1560
KTE-1216 W1200×T60×H1560



BELT / WIRING BELT TYPE

KBE-0716 W700×T60×H1560
KBE-0816 W800×T60×H1560
KBE-1016 W1000×T60×H1560
KBE-1216 W1200×T60×H1560



DOUBLE WIRING BELT TYPE

KEE-1216 W1200×T60×H1560

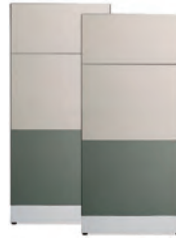

GENERAL TYPE

KTT-0618 W600×T60×H1760
KTT-0718 W700×T60×H1760
KTT-0818 W800×T60×H1760
KTT-1018 W1000×T60×H1760
KTT-1218 W1200×T60×H1760



SINGLE BELT TYPE

KTB-0618 W600×T60×H1760
KTB-0718 W700×T60×H1760
KTB-0818 W800×T60×H1760
KTB-1018 W1000×T60×H1760
KTB-1218 W1200×T60×H1760

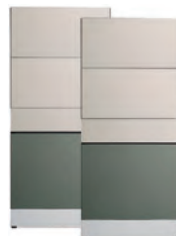

DOUBLE BELT TYPE

KBB-0618 W600×T60×H1760
KBB-0718 W700×T60×H1760
KBB-0818 W800×T60×H1760
KBB-1018 W1000×T60×H1760
KBB-1218 W1200×T60×H1760



SINGLE WIRING BELT TYPE

KTE-0718 W700×T60×H1760
KTE-0818 W800×T60×H1760
KTE-1018 W1000×T60×H1760
KTE-1218 W1200×T60×H1760



BELT / WIRING BELT TYPE

KBE-0718 W700×T60×H1760
KBE-0818 W800×T60×H1760
KBE-1018 W1000×T60×H1760
KBE-1218 W1200×T60×H1760



DOUBLE WIRING BELT TYPE

KEE-1218 W1200×T60×H1760



GENERAL TYPE

KTT-0612G W600×T60×H1160
KTT-0712G W700×T60×H1160
KTT-0812G W800×T60×H1160
KTT-1012G W1000×T60×H1160
KTT-1212G W1200×T60×H1160



GENERAL TYPE

KTT-0614G W600×T60×H1360
KTT-0714G W700×T60×H1360
KTT-0814G W800×T60×H1360
KTT-1014G W1000×T60×H1360
KTT-1214G W1200×T60×H1360

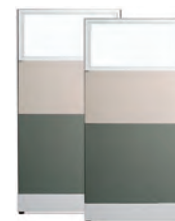

GENERAL TYPE

KTT-0616G W600×T60×H1560
KTT-0716G W700×T60×H1560
KTT-0816G W800×T60×H1560
KTT-1016G W1000×T60×H1560
KTT-1216G W1200×T60×H1560

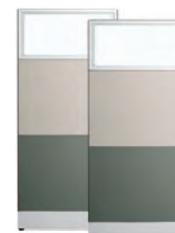

GENERAL TYPE

KTT-0618G W600×T60×H1760
KTT-0718G W700×T60×H1760
KTT-0818G W800×T60×H1760
KTT-1018G W1000×T60×H1760
KTT-1218G W1200×T60×H1760

PLANMAX

Partition innovation



701

PLANMAX is characterized by simple and sleek design elements.

It's practical and flexible design result in efficient communication and stability in an active work environment. However, simple and sleek design elements are without the sacrifice of strong and sturdy structure. Comfortable work environments are created for both multiple and individual workstations, resulting in greater work productivity and efficiency. Maximized use of space and facilitation of communication are both achieved with PLANMAX, with its simple design, which make altering the layout or specific units a breeze.





The combination of solid design and sleek color creates a luxurious office space.

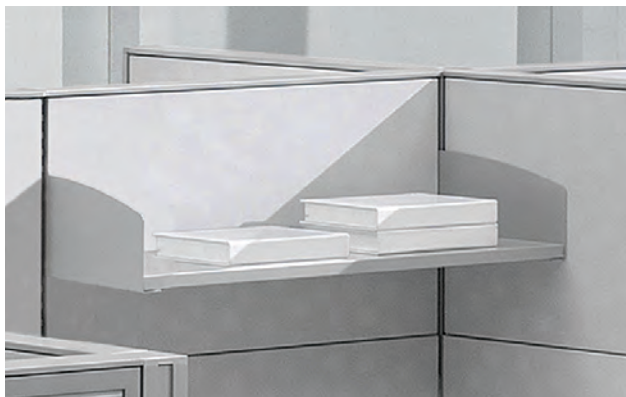

HANGING SHELF



GRILL TILE FOR ACCESSORIES / Paper tray, CD tray, Pen vase



FABRIC TILE

As the tile is made of iron plate and covered with fabric, it can be used as a memo board using a magnet.



SOUND ABSORBING TILE

As the sound-absorbing tile is built-in within the iron plate structure and is covered with fabric, sound absorption ability is very excellent.



GLASS TILE

The tile can be applied to the space in which user's privacy is secured and openness is required as well.



SCREEN GLASS TILE

As it is made of silk screen, the tile can be used more suitably than glass-tile when privacy is more required.



WIRING TILE

4-port receptacles and LAN conduit is attached on the tile.

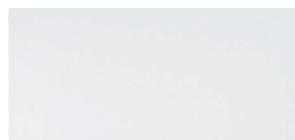

MARKER BOARD TILE

The tile can be used as a marker-board.



ACCESSORY GRILL TILE

Any other accessories can be angled on the rail-style groove.

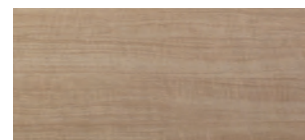

WOOD-PATTERN SHEET TILE

The tile is covered with wood-pattern sheet whose surface intensity is excellent and thus it is suitable for noble space.

70T (PLANMAX)



BELT TILE

It is designed by open-style allocating way, not frame-penetrating method. This method helps users control the allocation and the PLANMAX embeds a large amount of wires. Thus, this provides a perfect working environment for each users in the office.



BELT TILE HINGE

Developed by PLANMAX's own technique, spring hinge applied to belt tile opens and closes smoothly and makes allocating easy when fully opened.

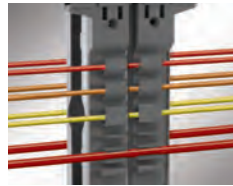

WIRING OF BELT LINE

Wire clip is attached in the middle of frame, so users can arrange the wires without twist of lines.



FINISH RUBBER

Rubber is attached to the bottom of belt tile, making the line drawn out easily.

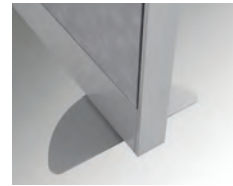

STABILIZER

Slim stabilizer, minimizing hooking foot.

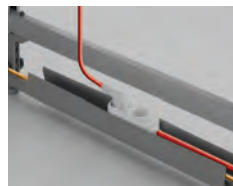

WIRING OF BASE LINE

Base emitting high impact engineering plastic ensures optimum space, and as guide-clip is parallel type, it is easy to arrange the lines. Also, wire housing enables large amount of allocation.



FRAME CONNECTOR

Using connector, PLANMAX's unique combination is made. The connector made of high impact plastic mould enables system-construction without any tools fast.



PLANMAX Series boasts its durability with the thickness of 70T and its metallic silver color meets the high standards of high end office furniture. PLANMAX shows you how the perfect wiring system can actively and inter-relatively improve your work environment.

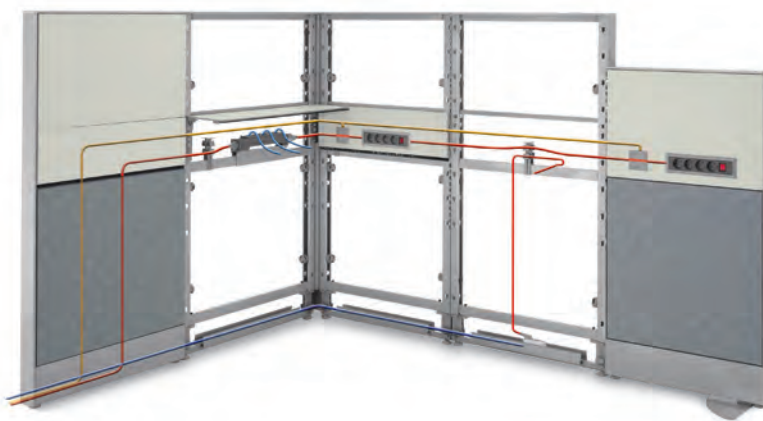

Sliding Door

Poly-Carbonate sliding door installed inside the Panel can be taken out conveniently when you need it and for worker's privacy and use. The door gives really smooth sliding.



TILE

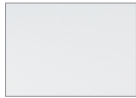

MARKER BOARD TILE

CT-0804B W789×T15×H398
CT-1004B W989×T15×H398



ACCESSORY GRILL TILE

CT-0602R W589×T14×H198
CT-0702R W689×T14×H198
CT-0802R W789×T14×H198
CT-1002R W989×T14×H198
CT-1202R W1189×T14×H198

CT-0604R W589×T14×H398
CT-0704R W689×T14×H398
CT-0804R W789×T14×H398
CT-1004R W989×T14×H398
CT-1204R W1189×T14×H398

OVERHEAD CABINET



CS-0602 W600xD343xH410
CS-0702 W700xD343xH410
CS-0802 W800xD343xH410
CS-1002 W1000xD343xH410
CS-1202 W1200xD343xH410

POST

L_TYPE



CP-10L W70×T70×H930
CP-12L W70×T70×H1130
CP-14L W70×T70×H1330
CP-16L W70×T70×H1530
CP-18L W70×T70×H1730

T_TYPE



CP-10T W70×T70×H930
CP-12T W70×T70×H1130
CP-14T W70×T70×H1330
CP-16T W70×T70×H1530
CP-18T W70×T70×H1730

X_TYPE

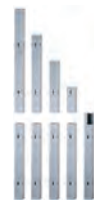

CP-10X W70×T70×H820
CP-12X W70×T70×H260/650
CP-14X W70×T70×H460/650
CP-16X W70×T70×H660/650
CP-18X W70×T70×H860/650

FINISHED COVER

SIDE



CE-10 W70×T13×H930
CE-12 W70×T13×H1130
CE-14 W70×T13×H1330
CE-16 W70×T13×H1530
CE-18 W70×T13×H1730

GAP



CE-02D W70×T13×H190
CE-04D W70×T13×H390
CE-06D W70×T13×H590
CE-08D W70×T13×H790

SHELF



CS-0601 W595×D300×H154
CS-0701 W695×D300×H154
CS-0801 W795×D300×H154
CS-1001 W995×D300×H154
CS-1201 W1195×D300×H154

RECEPACLE + RECEPTACLE HOLDER(IN)



SO-003 W312×D49×H112

PAPER SHELF



CA-301 W304×D223×H67

PAPER SHELF



CA-302 W113×D223×H314

CD SHELF

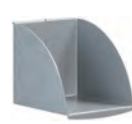

CA-303 W132×D140×H154

PEN VASE



CA-304 W85×D92xH122

STABILIZER



CA-100 W389×D155×H190

WALL BRACKET



KA-200 W70×D30×H45

Union Operation Model

H 960mm

H 1160mm

H 1360mm

GENERAL TYPE



CTT-0610 W600×T70×H960
CTT-0710 W700×T70×H960
CTT-0810 W800×T70×H960
CTT-1010 W1000×T70×H960
CTT-1210 W1200×T70×H960

GENERAL TYPE



CTT-0612 W600×T70×H1160
CTT-0712 W700×T70×H1160
CTT-0812 W800×T70×H1160
CTT-1012 W1000×T70×H1160
CTT-1212 W1200×T70×H1160

GENERAL TYPE



CTT-0614 W600×T70×H1360
CTT-0714 W700×T70×H1360
CTT-0814 W800×T70×H1360
CTT-1014 W1000×T70×H1360
CTT-1214 W1200×T70×H1360

SINGLE BELT TYPE



CTB-0610 W600×T70×H960
CTB-0710 W700×T70×H960
CTB-0810 W800×T70×H960
CTB-1010 W1000×T70×H960
CTB-1210 W1200×T70×H960

SINGLE BELT TYPE



CTB-0612 W600×T70×H1160
CTB-0712 W700×T70×H1160
CTB-0812 W800×T70×H1160
CTB-1012 W1000×T70×H1160
CTB-1212 W1200×T70×H1160

SINGLE BELT TYPE



CTB-0614 W600×T70×H1360
CTB-0714 W700×T70×H1360
CTB-0814 W800×T70×H1360
CTB-1014 W1000×T70×H1360
CTB-1214 W1200×T70×H1360

DOUBLE BELT TYPE



CBB-0610 W600×T70×H960
CBB-0710 W700×T70×H960
CBB-0810 W800×T70×H960
CBB-1010 W1000×T70×H960
CBB-1210 W1200×T70×H960

DOUBLE BELT TYPE

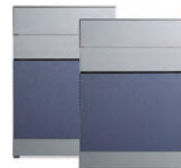

CBB-0612 W600×T70×H1160
CBB-0712 W700×T70×H1160
CBB-0812 W800×T70×H1160
CBB-1012 W1000×T70×H1160
CBB-1212 W1200×T70×H1160

DOUBLE BELT TYPE



CBB-0614 W600×T70×H1360
CBB-0714 W700×T70×H1360
CBB-0814 W800×T70×H1360
CBB-1014 W1000×T70×H1360
CBB-1214 W1200×T70×H1360

SINGLE WIRING BELT TYPE



CTE-0710 W700×T70×H960
CTE-0810 W800×T70×H960
CTE-1010 W1000×T70×H960
CTE-1210 W1200×T70×H960

SINGLE WIRING BELT TYPE



CTE-0712 W700×T70×H1160
CTE-0812 W800×T70×H1160
CTE-1012 W1000×T70×H1160
CTE-1212 W1200×T70×H1160

SINGLE WIRING BELT TYPE



CTE-0714 W700×T70×H1360
CTE-0814 W800×T70×H1360
CTE-1014 W1000×T70×H1360
CTE-1214 W1200×T70×H1360

BELT / WIRING BELT TYPE



CBE-0710 W700×T70×H960
CBE-0810 W800×T70×H960
CBE-1010 W1000×T70×H960
CBE-1210 W1200×T70×H960

BELT / WIRING BELT TYPE



CBE-0712 W700×T70×H1160
CBE-0812 W800×T70×H1160
CBE-1012 W1000×T70×H1160
CBE-1212 W1200×T70×H1160

BELT / WIRING BELT TYPE



CBE-0714 W700×T70×H1360
CBE-0814 W800×T70×H1360
CBE-1014 W1000×T70×H1360
CBE-1214 W1200×T70×H1360

DOUBLE WIRING BELT TYPE



CEE-1210 W1200×T70×H960

DOUBLE WIRING BELT TYPE



CEE-1212 W1200×T70×H1160

DOUBLE WIRING BELT TYPE



CEE-1214 W1200×T70×H1360

* WIRING BELT TYPE : ONLY APPLICATION THE W 700, 800, 1000, 1200
 * BOTH SIDES WIRING BELT TYPE : ONLY APPLICATION THE W 1200

H 1560mm

H 1760mm

GLASS TOP H1160 ~ H1760

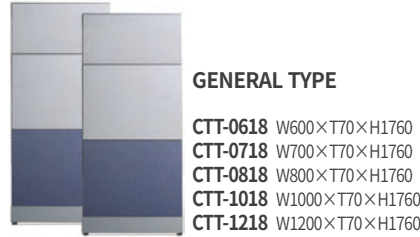
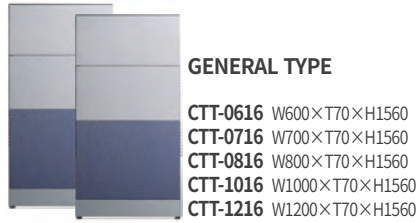

GENERAL TYPE

CTT-0612G W600×T70×H1160
CTT-0712G W700×T70×H1160
CTT-0812G W800×T70×H1160
CTT-1012G W1000×T70×H1160
CTT-1212G W1200×T70×H1160



GENERAL TYPE

CTT-0614G W600×T70×H1360
CTT-0714G W700×T70×H1360
CTT-0814G W800×T70×H1360
CTT-1014G W1000×T70×H1360
CTT-1214G W1200×T70×H1360



GENERAL TYPE

CTT-0616G W600×T70×H1560
CTT-0716G W700×T70×H1560
CTT-0816G W800×T70×H1560
CTT-1016G W1000×T70×H1560
CTT-1216G W1200×T70×H1560



GENERAL TYPE

CTT-0618G W600×T70×H1760
CTT-0718G W700×T70×H1760
CTT-0818G W800×T70×H1760
CTT-1018G W1000×T70×H1760
CTT-1218G W1200×T70×H1760



SLIDING DOOR

DSL-1016 W1000×T70×H1560
DSL-1018 W1000×T70×H1760
DSL-1216 W1200×T70×H1560
DSL-1218 W1200×T70×H1760

Design



WORKSTATION SERIES

HEAD DESK

VIBRANT

SUM UP

EXO

CUBE

FU_STAND

HEAD DESK

Office life creative

PM series

Ergonomic design HEAD DESK PM Series for a powerful TWO motor Height adjustments according to various work types enable you to stay healthy and stay focused.



Frame Color

- White
- Light Grey



PM201-DM
W1200-1800×D800×H720-1150mm

Height adjustable desk (Electric dual motor / 2 Column)



Height adjustment
H720~1150mm



Hand-set (Height adjustment, Memory (4) Height)



Collision prevention

Frame Color

- White



PM24M
W1200-1800×D800×H720-1200mm

Height adjustable desk (Hand crank)



Height adjustment H720~1200mm



Foldable crank



PSQ series

HEAD DESK PSQ Series with a wide range of height adjustments with the highest specifications
It provides a wide range of utilization to special facilities as well as users of different ages.



Height adjustable desk (Electric dual motor / 3 Column)



PSQ65
W1200~1800×D800×H650~1300mm



Height adjustment H650~1300mm



Hand-set (Height adjustment, Memory (4) Height) Collision prevention

Worktop Color



White

Maple

Walnut



Cut for wiring on the top

Accessory



400B_Fabric Screen

XNS112 W1200×D13×H400mm
XNS114 W1400×D13×H400mm
XNS116 W1600×D13×H400mm
XNS118 W1800×D13×H400mm



640B_Fabric Screen

FS612 W1200×D13×H640mm
FS614 W1400×D13×H640mm
FS616 W1600×D13×H640mm
FS618 W1800×D13×H640mm



PMH643_Accessory Set

Holder W645×D15×H200mm
Pen vase W85×D92×H122mm
Shelf_L W450×D168×H45mm
Shelf_S W300×D168×H45mm



Storage Drawer

DA02-1
 W513×D310~480×H108mm (Including brackets)
 W450×D310×H100mm (Only drawer)



Duct & Socket

PMD501 W430×D110×H95mm
PKM502 4 Socket / Code 1.5m



Holder & Socket

PKM502 4 Socket / Code 1.5m
MH01-1 Multi tap holder
 Available socket bar height H40~60mm
 Available worktop thickness 10~50mm



Anti Fatigue Mat

STM02-5 W855×D510×H19mm



CPU Holder_L

PMH 450 W120~200×D300×H500mm



CPU Holder_M

CPB-6 W88~203×H300~533mm

◀ (L) Turn left and right and adjust width according to CPU size.



Monitor riser

PSEM562 W500×D220×H60mm



Monitor riser

STB-124 W500×D202×H102mm

STEEL drawer

A modern and concise design of a steel drawer.
 Anti-tilting for safety.

 White  Light Grey



Pencil tray



Anti-tilting

PMP-003 W380×D470×H600mm

Smart Standing
SMARTING

Smart habits, Working standing
"SMARTING"

PMLU06-01N
W800×D615×H106-500mm

Table top W800×D400mm
Keyboard tray W795×D300mm
Base W764×D410mm

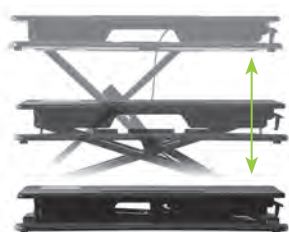

Vertical Adjustment



Eco-friendly Particle Board
Keyboard Tray



For Phones or Tablets

SITOOOL chair

More convenient design for use with height adjustable desks.



307BNA00Y
Seat 380×360 / H600-845mm
Fabric color: Black



(307B Black)



(304B Blue / 305B Gray)



304BNA00Y
Φ345×H645-890mm
Fabric color: Blue



305BNA00Y
Φ350×H610-855mm
Fabric color: Gray

VIBRANT

Work & Balance



VIBRANT office furniture system full of creative and positive energy.



Desk
Storage
Partition

Duct_type
Acrylic, Steel door
Screen, Fabric



Design
Slim & light Design



Round coner



Balance level



Wire management

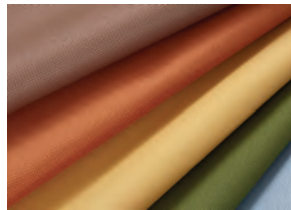

Color



Unique pattern design



Magnetic door



Side drawer



Drawer



Convenient Multi unit



Inertype handle

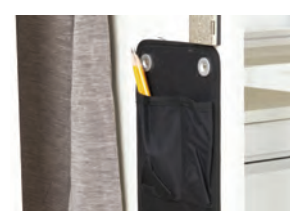

Multi pocket



Side cabinet on the desk



Side cabinet - Mini drawer



Side cabinet

Item List



Desk_Basic

- VMD012** W1200 x D800 x H720
- VMD014** W1400 x D800 x H720
- VMD016** W1600 x D800 x H720
- VMD018** W1800 x D800 x H720



Desk_Duct

- VMD012R** W1200 x D800 x H720
- VMD014R** W1400 x D800 x H720
- VMD016R** W1600 x D800 x H720
- VMD018R** W1800 x D800 x H720



Screen_Fabric

- VDF012** W1186 x D136(13) x H715(405)
- VDF014** W1386 x D136(13) x H715(405)
- VDF016** W1586 x D136(13) x H715(405)
- VDF018** W1786 x D136(13) x H715(405)



Screen_Acrylic

- VDF012A** W1186 x D136(13) x H715(405)
- VDF014A** W1386 x D136(13) x H715(405)
- VDF016A** W1586 x D136(13) x H715(405)
- VDF018A** W1786 x D136(13) x H715(405)



Overhead cabinet - Basic
VMC108T W800 x D315 x H440
 *Door_Iron plate / Option_Fabric



Overhead cabinet - Pencil drawer
VMC108TP W800 x D315 x H440
 *Door_Iron plate / Option_Fabric



Desk - 2 drawer
VMC108TPP W770 x D330 x H465
 *Door_Iron plate / Option_Fabric



Multi storage
VMC442L/R W400 x D800 x H1162

VMC442R



Side cabinet
VMC082 W800 x D390 x H500



Side cabinet - Drawer
VMC082P W800 x D390 x H500



Drawer
VMP0303 W402 x D520 x H594



Horizontal duct
VA0301 W600 x D150 x H200



Multitap + Lan
MC0501L 5+1 Multitap / 2Lan

SUM UP

Work & Balance



It is the most efficient office system created by the concentration of the most essential and key elements in the office furniture market.

Desk
Storage
Partition

Desk_L type
3-Stage drawer + Head / U-shaped extension
Belt





Efficient & Convenient wire management



Multi tap box



Cable cap



Slim & light Design



Balance leveler



Modesty panel



Convenient Multi unit



Inertype handle



Round face



Drawer



Pencil drawer



Visual lock system

Details



Curved table top



Balance leveler



U type leg



Efficient



Convenient



Pencil drawer



Inertype handle



Multi unit + Upper storage

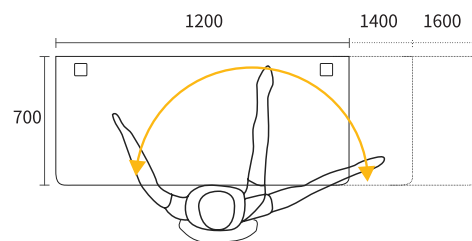

Desk_Basic

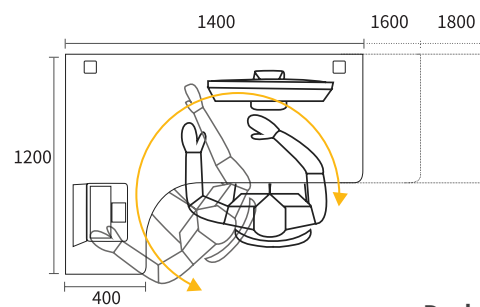

Desk_L type



Desk_L type

EED314 W1400 × D1200 × H720
EED316 W1600 × D1200 × H720
EED318 W1800 × D1200 × H720



Desk

EED112 W1200 × D700 × H720
EED114 W1400 × D700 × H720
EED116 W1600 × D700 × H720



Desk_Side plate type

EED012 W1200 × D700 × H720
EED014 W1400 × D700 × H720
EED016 W1600 × D700 × H720



Extension_U type

EED912C W600 × D1200 × H720



Side table_D600

EED162 W600 × D500 × H720
EED162D W600 × D500 × H720
 * D : Door type



Side table_D600

EED182 W800 × D500 × H720
EED182D W800 × D500 × H720
 * D : Door type



Drawer with storage

VMP0703T W400 × D400 × H1162



Drawer

VMP0703 W400 × D400 × H720



Upper storage

EED060T H600
EED080T H800



Drawer

VMP0303 W402 × D520 × H594



Closet_1 person

EEC548 W200 × D700 × H1162



Closet_2 person

EEC585 W400 × D700 × H1162



Horizontal duct

VA0301 W600 × D150 × H200



Multitap + Lan

MC0501L 5+1 Multitap/
2Lan

EXO

Multi-Functional Storage



Optimal work environment is provided with accessories and storage options, which stand out for various ideas.

Desk
Storage
Screen

Single desk
Combi side cabinet with door
Wooden





Strong steel frame



Edge design & Wire-cab



Bracket & Balance level



Fabric door



Steel door



Magnetic door



3 to 4 step drawer

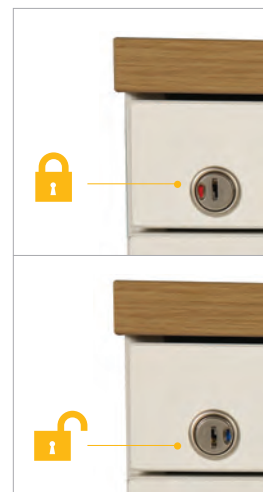

Visual lock system

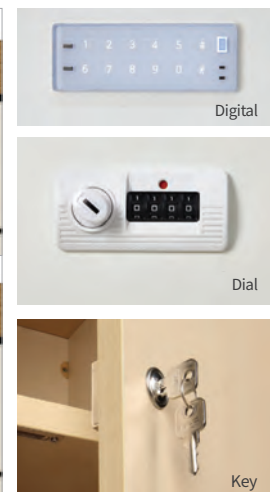

3 option locking



PC cabinet



Design handle



Extension plate

Item List



Desk

TMD008	W800 × D800 × H720
TMD010	W1000 × D800 × H720
TMD012	W1200 × D800 × H720
TMD014	W1400 × D800 × H720
TMD016	W1600 × D800 × H720
TMD018	W1800 × D800 × H720



Modesty panel

TML008	W690 × D18 × H390
TML010	W890 × D18 × H390
TML011	W990 × D18 × H390
TML012	W1090 × D18 × H390
TML013	W1190 × D18 × H390
TML014	W1290 × D18 × H390
TML015	W1390 × D18 × H390
TML016	W1490 × D18 × H390
TML018	W1690 × D18 × H390



Screen(H600)

TMU008	W690 × D18 × H600
TMU010	W890 × D18 × H600
TMU011	W990 × D18 × H600
TMU012	W1090 × D18 × H600
TMU013	W1190 × D18 × H600
TMU014	W1290 × D18 × H600
TMU015	W1390 × D18 × H600
TMU016	W1490 × D18 × H600
TMU018	W1690 × D18 × H600



TMD1163PR

Desk with single (2/3) drawer

TMD1142PL/R	W1400 × D800 × H720
TMD1162PL/R	W1600 × D800 × H720
TMD1182PL/R	W1800 × D800 × H720

TMD1143PL/R	W1400 × D800 × H720
TMD1163PL/R	W1600 × D800 × H720
TMD1183PL/R	W1800 × D800 × H720



TMD216P

Desk with double drawer

TMD216P	W1600 × D800 × H720
TMD218P	W1800 × D800 × H720
TMD220P	W2000 × D800 × H720



TMD116CR

Desk with single cabinet

TMD114CL/R	W1400 × D800 × H720
TMD116CL/R	W1600 × D800 × H720
TMD118CL/R	W1800 × D800 × H720



TMD2162CR

Desk with single (2/3) drawer & single cabinet

TMD2162CL/R	W1600 × D800 × H720
TMD2182CL/R	W1800 × D800 × H720
TMD2202CL/R	W2000 × D800 × H720

TMD2163CL/R	W1600 × D800 × H720
TMD2183CL/R	W1800 × D800 × H720
TMD2203CL/R	W2000 × D800 × H720



TMD116UR

Desk with PC cabinet

TMD114UL/R	W1400 × D800 × H720
TMD116UL/R	W1600 × D800 × H720
TMD118UL/R	W1800 × D800 × H720



TMD2162UR

Desk with single (2/3) drawer & PC cabinet

TMD2162UL/R	W1600 × D800 × H720
TMD2182UL/R	W1800 × D800 × H720
TMD2202UL/R	W2000 × D800 × H720

TMD2163UL/R	W1600 × D800 × H720
TMD2183UL/R	W1800 × D800 × H720
TMD2203UL/R	W2000 × D800 × H720



CPU holder

TMX101	W320 × D260 × H635
TMX102	W320 × D260 × H635



Multi tap

TMX901A	W175 × D88 × H82
TMX901B	W225 × D88 × H82
TMX901C	W275 × D88 × H82



Multi tap with LAN & USB

TMX902A	W238 × D88 × H82
TMX902B	W288 × D88 × H82
TMX902C	W338 × D88 × H82

Item List

※D_door / E_electronic / A_dial



TMC616FR

Overhead cabinet with sliding door (fabric finish)

TMC616FL/R W1600 × D360 × H556
TMC618FL/R W1800 × D360 × H556



TMC616R

Overhead cabinet with sliding door (perforated)

TMC616L/R W1600 × D360 × H556
TMC618L/R W1800 × D360 × H556



TMC183PDL

Side cabinet with door

TMC182PDL/R W800 × D520 × H606
TMC183PDL/R W800 × D520 × H606
TMC1102PDL/R W1000 × D520 × H606
TMC1103PDL/R W1000 × D520 × H606



TMC183PL

Side cabinet without door

TMC182PL/R W800 × D520 × H606
TMC183PL/R W800 × D520 × H606
TMC1102PL/R W1000 × D520 × H606
TMC1103PL/R W1000 × D520 × H606



TMD183PDL

Side cabinet with top & door

TMD182PDL/R W800 × D520 × H720
TMD183PDL/R W800 × D520 × H720
TMD1102PDL/R W1000 × D520 × H720
TMD1103PDL/R W1000 × D520 × H720



TMD183PL

Side cabinet with top

TMD182PL/R W800 × D520 × H720
TMD183PL/R W800 × D520 × H720
TMD1102PL/R W1000 × D520 × H720
TMD1103PL/R W1000 × D520 × H720



TMC525L TMC528R

Closet_1 person

TMC525L/R W200 × D520 × H1162
TMC528L/R W200 × D800 × H1162
TMC528L/RE W200 × D800 × H1162



TMC545 TMC585

Closet_2 person

TMC545 W400 × D520 × H1162
TMC585 W400 × D800 × H1162



TMC545MR TMC585MR

Mult Closet

TMC545ML/R W400 × D520 × H1162
TMC585ML/R W400 × D800 × H1162
TMC585ML/RE W400 × D800 × H1162



Drawer

TMP0402
W404 × D550 × H595



Drawer

TMP0403
W404 × D550 × H595



Drawer with pencil tray

TMP0412
W404 × D550 × H595
TMP0412E
W404 × D550 × H595



Drawer with pencil tray

TMP0413
W404 × D550 × H595
TMP0413E
W404 × D550 × H595

CUBE

Cube is designed to flexibly adjust to various layouts with its wide range of units, while maintaining its aesthetic appeal and sophistication. Rearranging the modules is open to limitless possibilities, fostering both a harmonious and creative work environment.



- Desk** L type desk
- Side desk** U type table
- Storage** Side cabine with door / drawer
- Partition** Belt and top glass tile





Modern leg



Balance level



Rubber edge

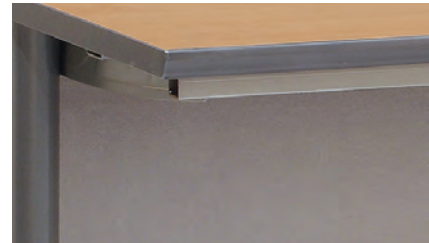

Durable desk top



Mobile drawer



Pencil drawer

Design



CUBE Series

Item List



Desk_L/R type

UAD316L/R W1600 × D1200(700) × H720
UAD318L/R W1800 × D1200(700) × H720



Desk_Wide

UAD014 W1400 × D700 × H720
UAD016 W1600 × D700 × H720
UAD018 W1800 × D700 × H720



Desk_Small

UAD008 W800 × D700 × H720
UAD010 W1000 × D700 × H720
UAD012 W1200 × D700 × H720



Sub drawer

UAP143 W400 × D700 × H720



Drawer

UAP1403 W400 × D588 × H668



Drawer

UAP0402 W404 × D540 × H595



Drawer

UAP0403 W404 × D540 × H595



Side table

UAD912C W1200 × D600 × H720



Side cabinet

UAC162 W600 × D500 × H720
UAC182 W800 × D500 × H720



Side cabinet with door

UAC162D W600 × D500 × H720
UAC182D W800 × D500 × H720

FU_STAND

Top & Square Desk Series

Workstations are a layout that combines independence and individuality to suit the space conditions due to the nature of their work. Create a positive working atmosphere and a creative workplace with maximum efficiency for your individual or professional work.





Edge Color



Wood Color (Desk)



Fuzzle desk

KIOF-4901
W1200×D800×H720
W1400×D800×H720
W1600×D800×H720
W1800×D800×H720



Feature



Aesthetic edge finish

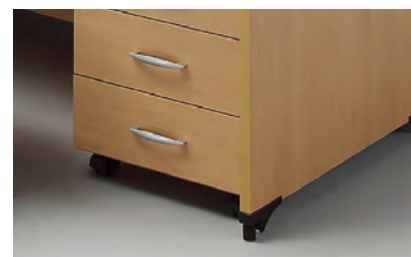

Horizontal adjustment

Square Desk



Standing desk (Insert type)

KIOF-5101 W1400×D800×H720
W1600×D800×H720
W1800×D800×H720



Desk

KIOF-5102 W1200×D800×H720
W1400×D800×H720
W1600×D800×H720
W1800×D800×H720



Credenza

KIOF-5103 W1500×D400×H750



Aluminium handle



Bookshelf

KIOF-5104 W900×D250×H250

Wood Color (Items)



White



White ash

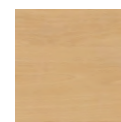

Beach



Oak

Feature



Standing desk (Insert type)

Available in a maximum height of 34cm from the top, the height can be adjusted step by step to suit the user's preference.



Wire management

Item List



Drawer / U
KIOF-5201
W400×D550×H600



Drawer / U
KIOF-5202
W400×D550×H600



Drawer / F
KIOF-5203
W400×D550×H600



Drawer / F
KIOF-5204
W400×D550×H600



Drawer / A
KIOF-5205
W400×D550×H600



Drawer / B
KIOF-5206
W400×D550×H600



Side cabinet
KIOF-5207
W600×D400×H720



Side cabinet with door
KIOF-5208
W600×D400×H720



**Side table with cabinet
(without door)**
KIOF-5209
W600×D1200×H720



**Side table with cabinet
(with door)**
KIOF-5210
W600×D1200×H720



Side table / A
KIOF-5211
W600×D1200×H720



Side table / B
KIOF-5212
W600×D1200×H720

Details



Wardrobe



Multifunctional pencil tray



Divide storage space



File storage space

Item List



Multi storage
KIOF-5301
 W600×D600×H1200

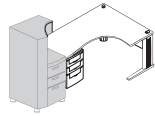

L Type

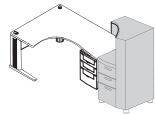

R Type



Wardrobe (1)
KIOF-5302
 W250×D700×H1200



Wardrobe (2)
KIOF-5303
 W500×D700×H1200



Cabinet
KIOF-5401
 W800×D400×H800



Cabinet with door
KIOF-5402
 W800×D400×H800



Buried handle

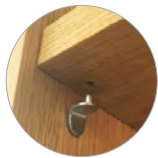

Cabinet
KIOF-5403
 W800×D400×H1200



Cabinet with half door
KIOF-5404
 W800×D400×H1200



Cabinet with door
KIOF-5405
 W800×D400×H1200



Cabinet
KIOF-5406
 W800×D400×H1500



Cabinet with half door
KIOF-5407
 W800×D400×H1500



Cabinet with door
KIOF-5408
 W800×D400×H1500

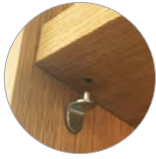

Cabinet
KIOF-5501 W800×D400×H1900



Cabinet with half door
KIOF-5502 W800×D400×H1900



Cabinet with door
KIOF-5503 W800×D400×H1900

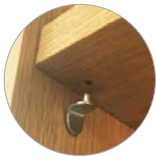

Cabinet with glass door
KIOF-5504 W800×D400×H1900



Cabinet with half glass door
KIOF-5505 W800×D400×H1900



Wardrobe
KIOF-5506 W500×D500×H1900

Handle & Key (Option)



Electronic key (Touch)



Electronic key button type



Dial key